

64

Q.P. Code : 24950

[Time: 3 Hours]

[Marks: 80]

- N.B:
1. Question No. 1 is compulsory.
 2. Attempt any three from remaining questions.

1. a) Find voltages V_1 and V_2 by nodal Analysis for the circuit given below. 5

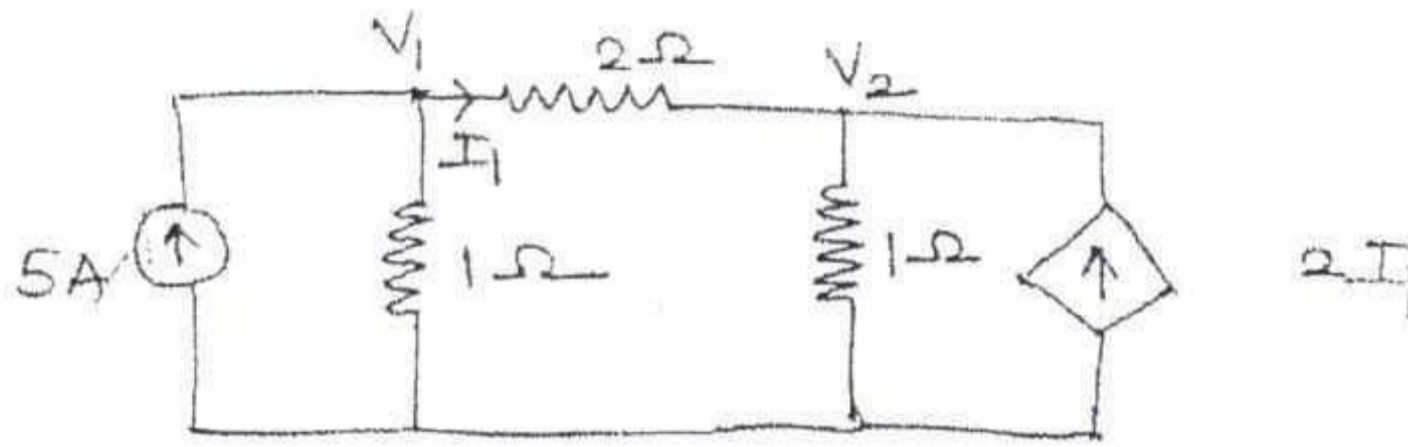

- b) Find Z parameter of the following two port network. 5

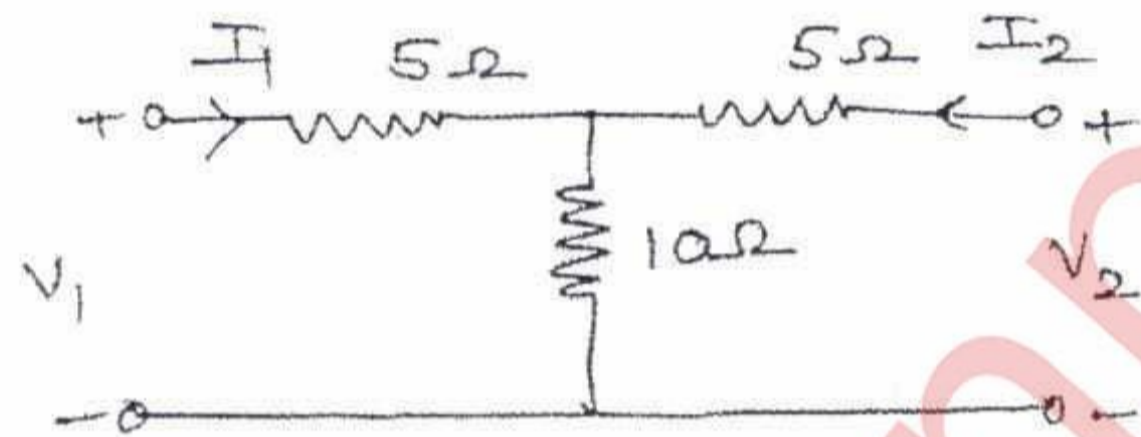

- c) Synthesize in cauer I, cauer II, Foster I and Foster II forms. 5

$$Z(s) = \frac{s}{(s+2)}$$

- d) For the Network shown find v_c/v . Also draw pole-zero plot. 5



2. a) Find the current through 5Ω Resistor using superposition theorem. 10

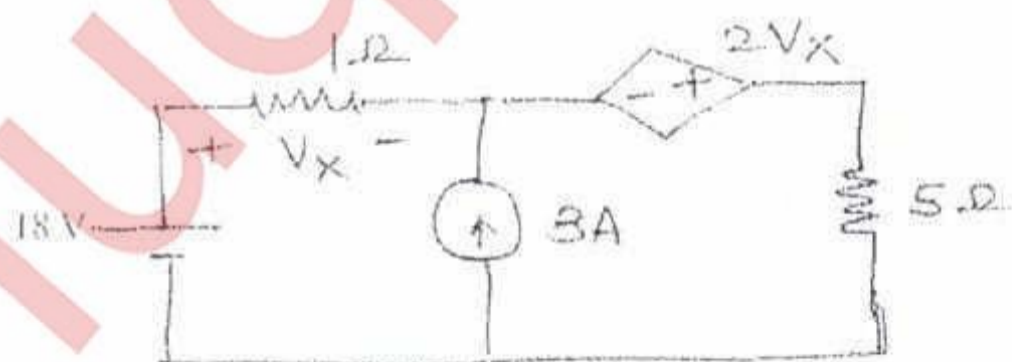

Turn Over

- b) Draw the oriented graph for the following circuit and obtain its incidence matrix. 5

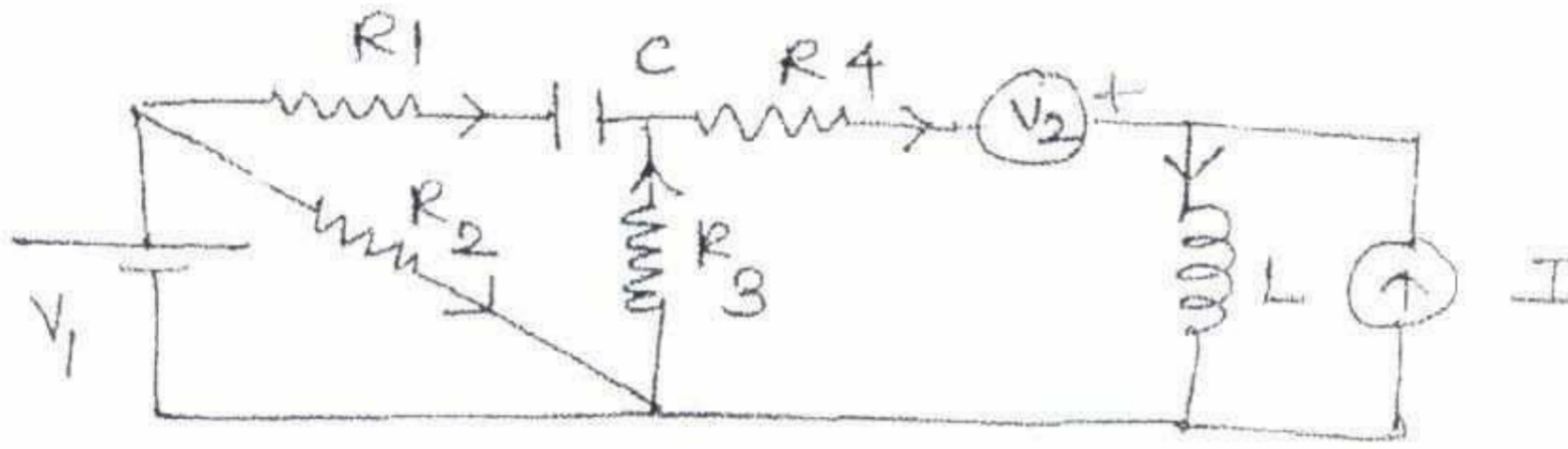

- c) Find the condition for symmetry and Reciprocity in terms of Z parameter. 5

3. a) Realise $Z(s)$ in foster I and foster II form. 10

$$Z(s) = \frac{s(s^2 + 4)}{(s^2 + 1)(s^2 + 9)}$$

- b) In the following series RC circuit switch is closed at $t = 0$. Find $i(t)$ and $v_c(t)$ for $t > 0$. 5

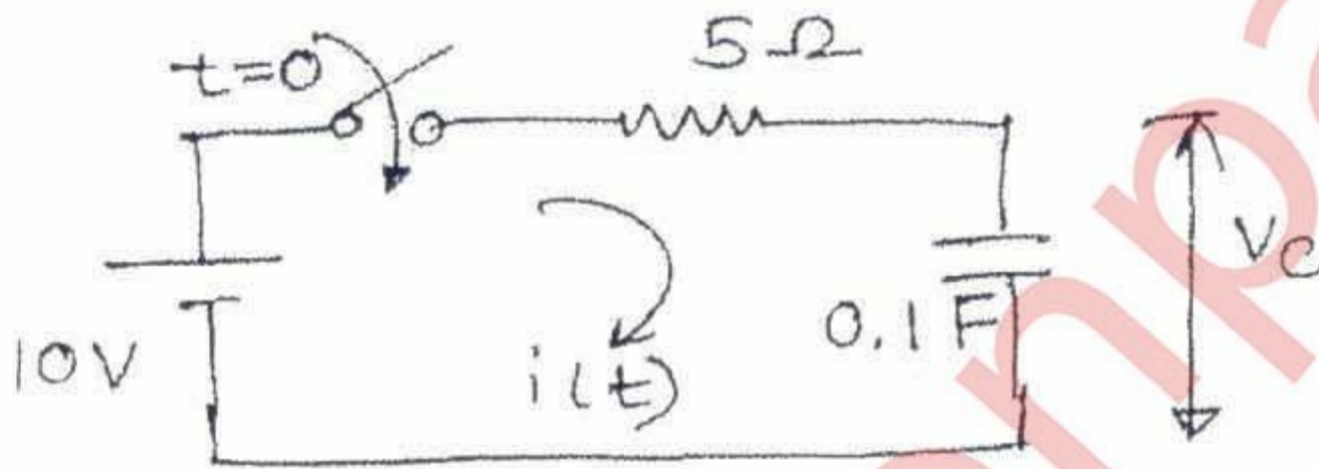

- c) Test whether the given polynomial is Hurwitz 5
 i) $S^4 + 7S^3 + 6S^2 + 21S + 8$
 ii) $S^5 + S^3 + S$

4. a) Find ABCD parameters of the following Network. 10

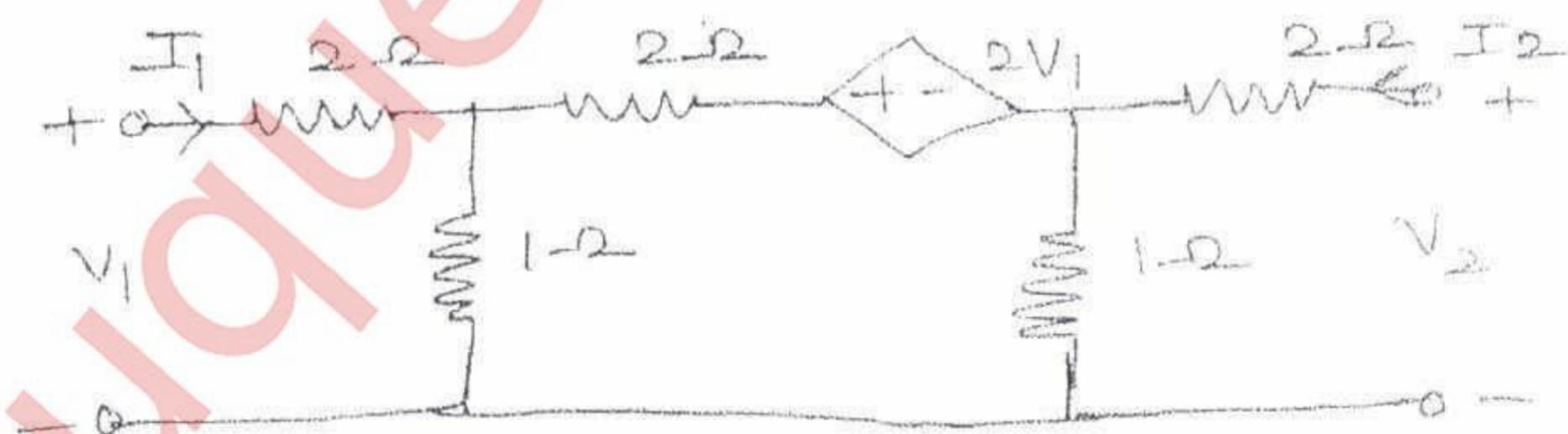

Turn Over

b) Test for positive Real function

$$F(S) = \frac{S^2 + 4}{(S^3 + 3S^2 + 3S + 1)}$$

c) Find I_2 using Mesh Analysis

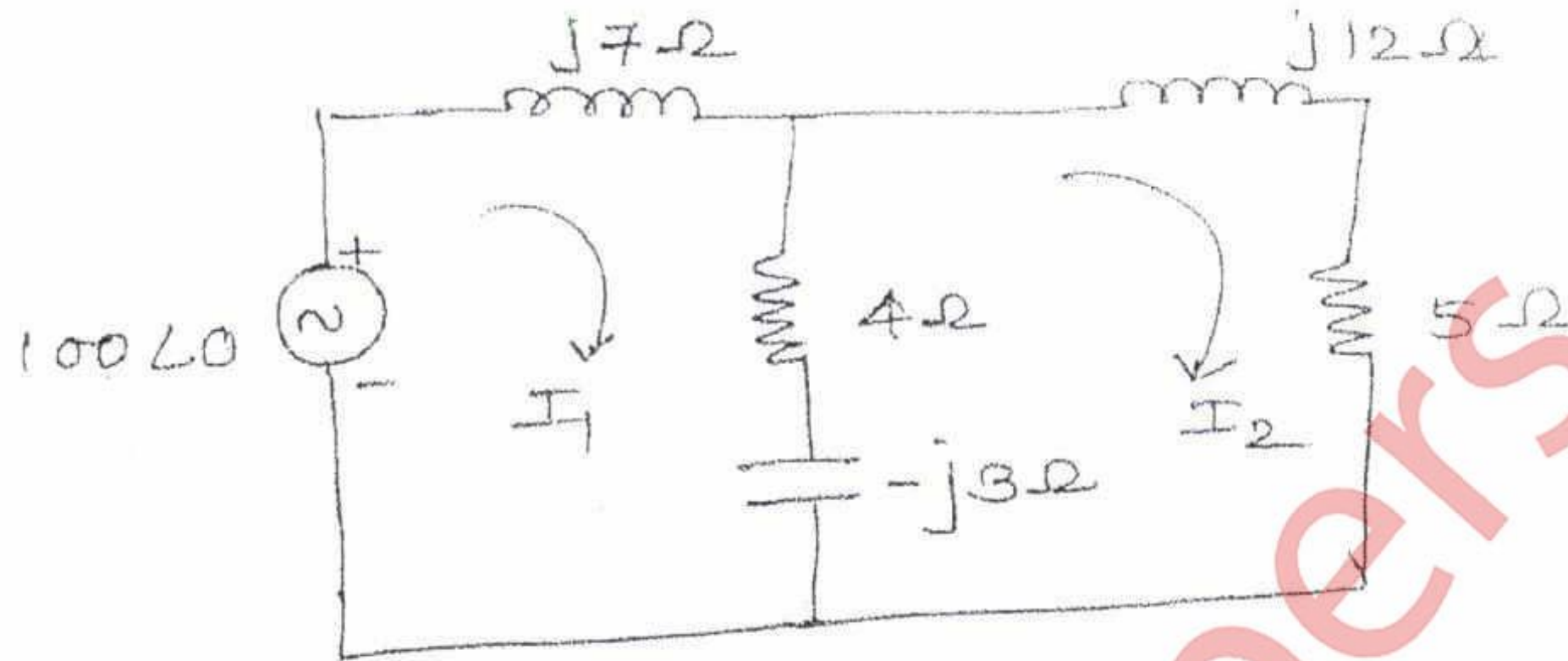

5

5

5. a) Obtain equilibrium equation using KVL in matrix form. Hence find link currents.

10

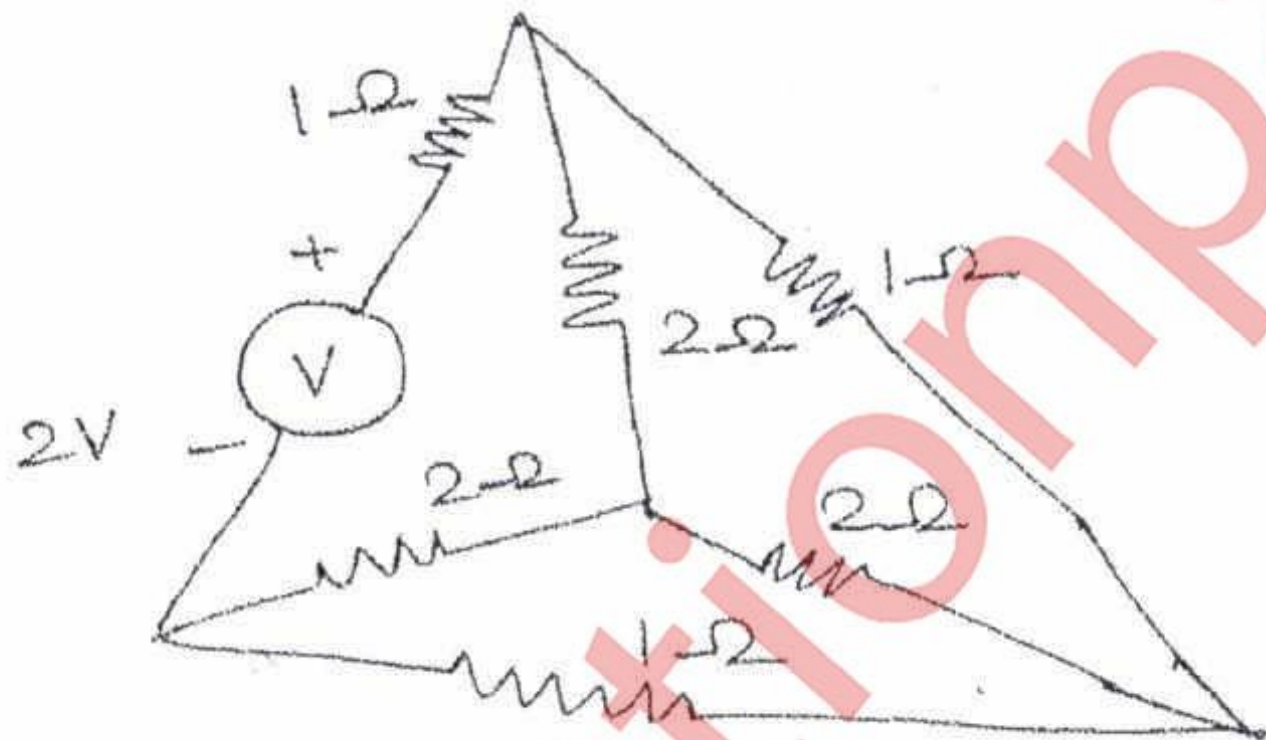

b) In the network given below the switch is closed for a long time and opened at $t = 0$

5

Find $v(0^+)$, $\frac{dv}{dt}(0^+)$ and $\frac{dv^2}{dt^2}(0^+)$

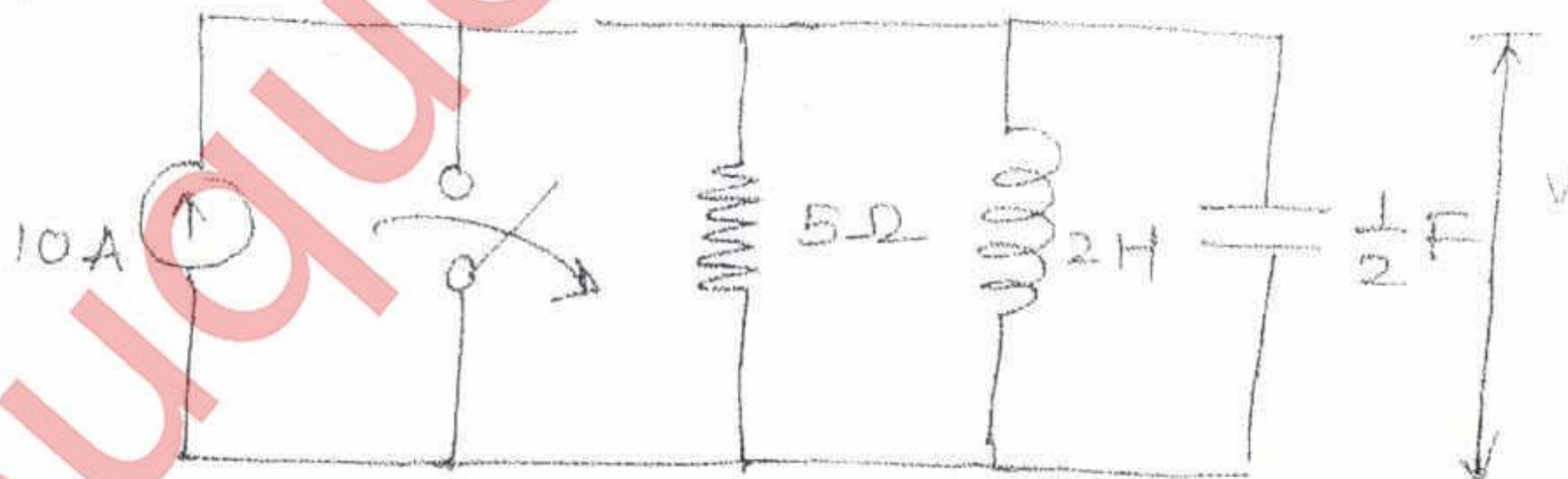

Turn Over

- c) The switch is closed at $t = 0$. Determine current $i(t)$, assuming zero initial condition, using Laplace transform. 5

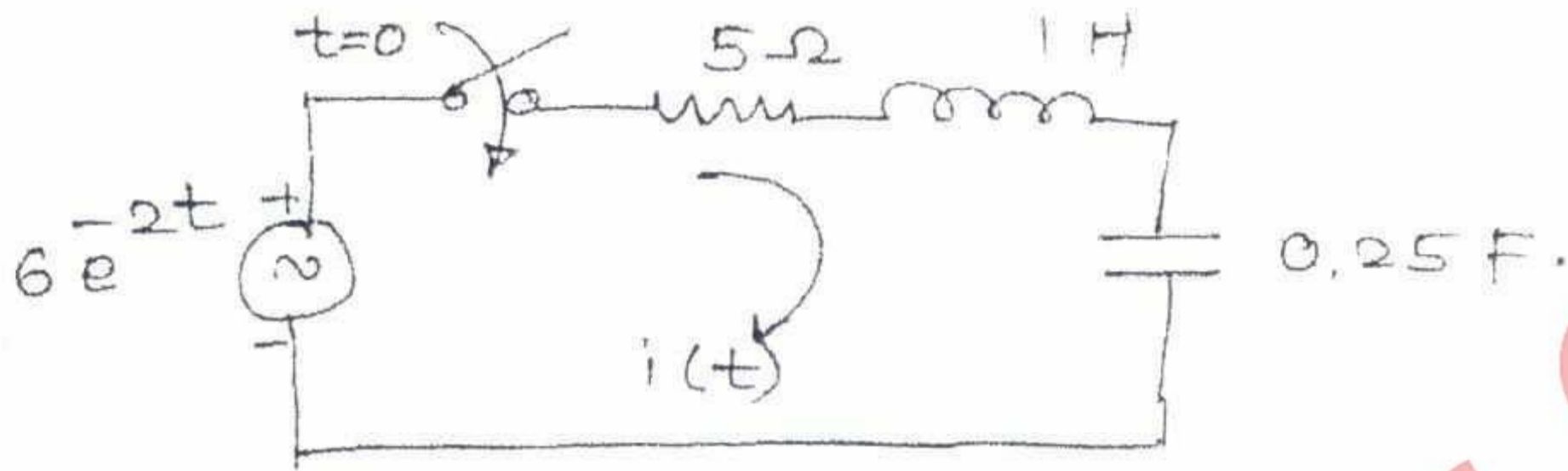

6. a) For the ladder Network shown below obtain $V_1/V_2, V_2/I_1$. 10

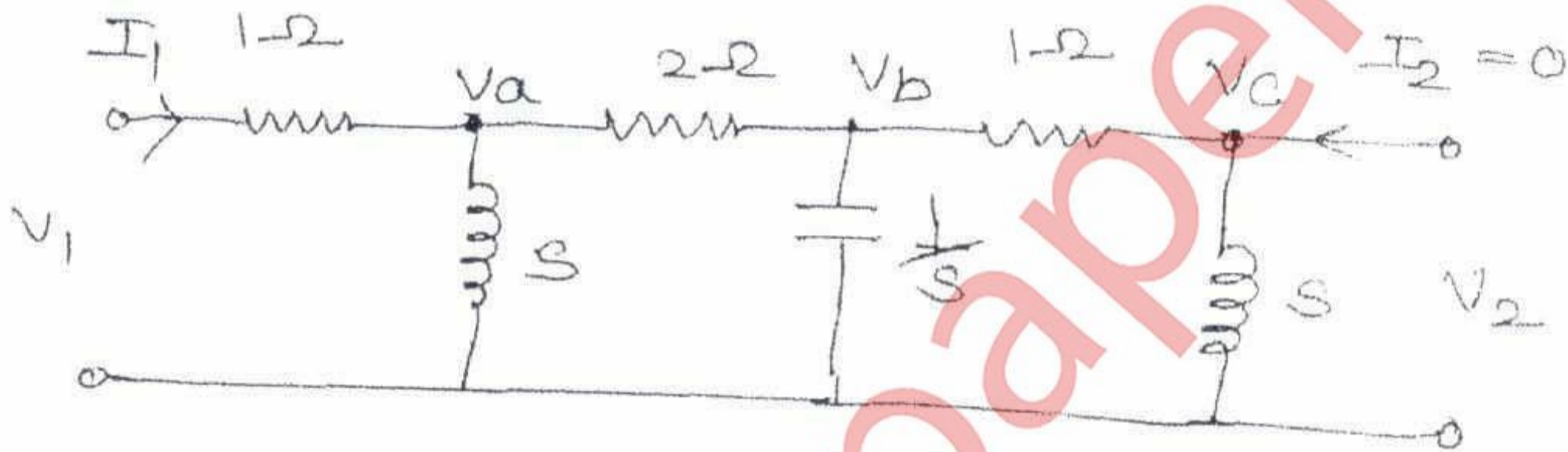

- b) Find Z parameters in terms of Y parameters. 5
 c) Obtain Tieset and f-cutset matrix for the following graph. 5

